

Exam : Cisco 642-812

**Title : BCMSN - Building
Converged Cisco Multilayer
Switched Networks**

Version : Demo



Top 3 Customers in Test4pass - Best IT certifications Team



Abbigail, who is proficient in Microsoft technology. After read our Study guides of Microsoft , She think test4pass is the best for IT candidates.

is the best for IT candidates.



Ramsden, who was majored in Manager IT technologys. He has many years of education experience. With his help, many of his candidates have won the certificate. he said:

test4pass' materials are the real one!



The IT experts of American company are training with test4pass braindumps, the manager of the company said: that will help them a lot

by using test4pass.

HOT Certifications On Test4pass

Cisco Certifications

[CCNA](#) [CCDA](#) [CCNP](#) [CCDP](#) [CCVP](#) [CCSP](#) [CCIP](#) [CCIE](#) [CCDE](#) [Data Center](#) [Sales Expert](#)

Microsoft Certifications

[MCP](#) [MCSE](#) [MCITP](#) [MCTS](#) [MCSE2003](#) [MCPD](#) [MCS.D.NET](#) [MCDST](#) [TS](#) [Exchange Server2007](#)
[MCSE2003 Security](#) [MCSE2003 Messaging](#) [Microsoft Business Solutions](#)

IBM Certifications

[Certified Administrator](#) [Certified Systems Expert](#) [Solutions Expert](#) [System Administrator](#)
[DB2](#) [Certified Advanced Technical Expert](#) [Certified Advanced System Administrator](#)
[Lotus Certification](#) [WebSphere Cognos 8 BI](#) [Certified Associate Developer](#) [Tivoli Software](#)

CompTIA Certifications

[A+](#) [CDIA+](#) [CTT+](#) [e-Biz+](#) [CompTIA HTI+](#) [i-NET+](#) [Linux+](#) [Network+](#) [Project+](#) [RFID+](#) [Security+](#)
[Server+](#) [PDI+](#) [Convergence+](#)

1. Refer to the exhibit. What is the effect on the trust boundary of configuring the command `mls qos trust cos` on the switch port that is connected to the IP phone?

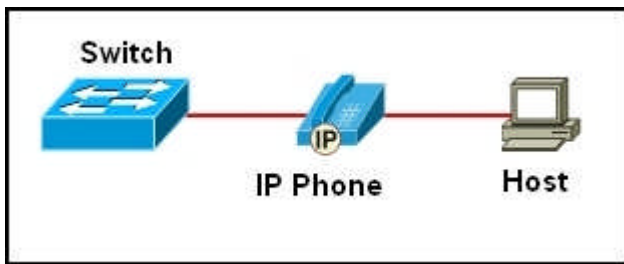

- A. Effectively the trust boundary has been moved to the IP phone.
- B. The host is now establishing the CoS value and has effectively become the trust boundary.
- C. The switch is rewriting packets it receives from the IP phone and determining the CoS value.
- D. The switch will no longer tag incoming voice packets and will trust the distribution layer switch to set the CoS.
- E. RTP will be used to negotiate a CoS value based upon bandwidth utilization on the link.

Answer: A

2. Refer to the exhibit. What is the effect when the switchport priority extend `cos 3` command is configured on the switch port interface connected to the IP phone?



- A. Effectively, the trust boundary has been moved to the PC attached to the IP phone.
- B. The computer is now establishing the CoS value and has effectively become the trust boundary.
- C. The IP phone is enabled to override with a CoS value of 3 the existing CoS marking of the PC attached to the IP phone.
- D. The switch will no longer tag incoming voice packets and will extend the trust boundary to the distribution layer switch.
- E. RTP will be used to negotiate a CoS value based upon bandwidth utilization on the link.

Answer: C

3. Which three WLAN statements are true? (Choose three.)

- A. A lightweight AP receives control and configuration from a WLAN controller to which it is associated.
- B. A WLAN client that is operating in half-duplex mode will delay all clients in that WLAN.

- C. Ad hoc mode allows mobile clients to connect directly without an intermediate AP.
- D. Another term for infrastructure mode is independent service set (IBSS).
- E. The Aironet 1230 access point is an example of an access point that operates solely as a lightweight access point.
- F. WLANs are designed to share the medium and can easily handle an increased demand of channel contention.

Answer: ABC

4. Which statement is true about IP telephony calls?

- A. A Voice over IP (VoIP) packet consists of the voice payload, IP header, TCP header, RTP header, and Layer 2 link header.
- B. The voice carrier stream uses H.323 to set up, maintain, and tear down call endpoints.
- C. Call control signaling uses Real-Time Transport Protocol (RTP) packets that contain actual voice samples.
- D. The sum of bandwidth necessary for each major application, including voice, video, and data, should not exceed 75 percent of the total available bandwidth for each link.

Answer: D

5. Which statement about the Lightweight Access Point Protocol (LWAPP) is true?

- A. LWAPP encrypts control traffic between the AP and the controller.
- B. LWAPP encrypts user traffic with a x.509 certificate using AES-CCMP.
- C. LWAPP encrypts both control traffic and user data.
- D. When set to Layer 3, LWAPP uses a proprietary protocol to communicate with the Cisco Aironet APs.

Answer: A

6. Which statement is true about RSTP topology changes?

- A. Any change in the state of the port generates a TC BPDU.
- B. Only nonedge ports moving to the forwarding state generate a TC BPDU.
- C. If either an edge port or a nonedge port moves to a block state, then a TC BPDU is generated.
- D. Only nonedge ports moving to the blocking state generate a TC BPDU.

E. Any loss of connectivity generates a TC BPDUs.

Answer: B

7. Refer to the exhibit. Switch S2 contains the default configuration. Switches S1 and S3 both have had the command spanning-tree mode rapid-pvst issued on them. What will be the result?

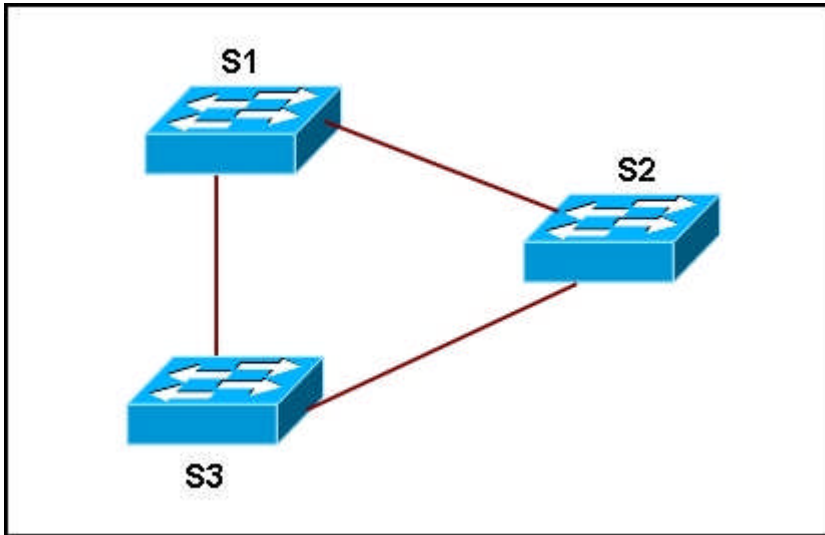

- A. Switches S1 and S3 will be able to exchange traffic but neither will be able to exchange traffic with Switch S2
- B. Switches S1, S2, and S3 will be able to pass traffic between themselves. However, if there is a topology change, Switch S2 will not receive notification of the change.
- C. Switches S1, S2, and S3 will be able to pass traffic among themselves.
- D. IEEE 802.1D and IEEE 802.1w are incompatible. All three switches must use the same standard or no traffic will pass between any of the switches.

Answer: C

8. Refer to the exhibit. Switch S1 has been configured with the command spanning-tree mode rapid-pvst. Switch S3 has been configured with the command spanning-tree mode mst. Switch S2 is running the IEEE 802.1D instance of Spanning-Tree. What will be the result?

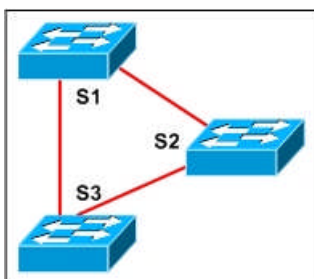

- A. IEEE 802.1w, and IEEE 802.1s are compatible. IEEE 802.1d is incompatible. Switches S1 and S3 will be able to pass traffic between themselves. Neither will be able to pass traffic to Switch S2.
- B. Switches S1, S2, and S3 will be able to pass traffic between themselves.
- C. Switches S1, S2, and S3 will be able to pass traffic between themselves. However, if there is a topology change, Switch S2 will not receive notification of the change.
- D. IEEE 802.1d, IEEE 802.1w, and IEEE 802.1s are incompatible. All three switches must use the same standard or no traffic will pass between any of the switches.

Answer: B

9. Which issue or set of issues does the Lightweight Access Point Protocol (LWAPP) address?

- A. reduction of processing in wireless controllers
- B. distributed approach to authentication, encryption, and policy enforcement
- C. provides security by blocking communication between access points and wireless clients
- D. access point discovery, information exchange, and configuration

Answer: D

10. Refer to the exhibit. Which statement is true about where trust boundaries should be established in a network?

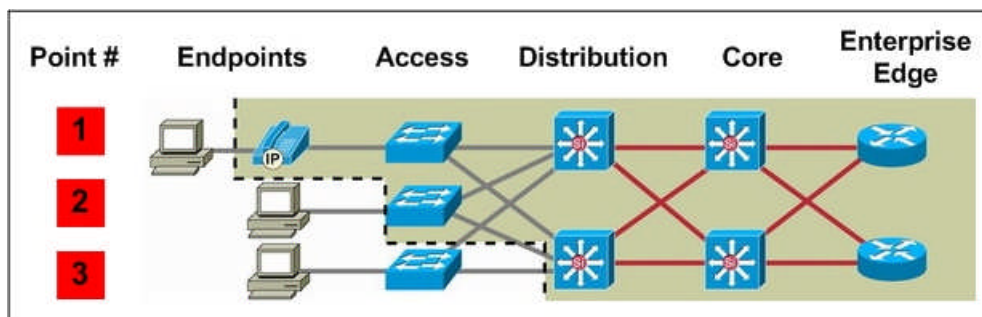

- A. Endpoint 1 is the only acceptable place to establish a trust boundary.
- B. Endpoint 1 is the optimal place to establish a trust boundary. Endpoints 2 and 3 are acceptable places to establish a trust boundary.
- C. Endpoint 2 is the only acceptable place to establish a trust boundary.
- D. Endpoint 2 is the optimal place to establish a trust boundary. Endpoints 1 and 3 are acceptable places to establish a trust boundary.
- E. Endpoints 1 and 2 are optimal places to establish a trust boundary. Endpoint 3 is an acceptable place to

establish a trust boundary.

F. Endpoints 2 and 3 are optimal places to establish a trust boundary. Endpoint 1 is an acceptable place to establish a trust boundary.

Answer: E

11. Refer to the exhibit. Which three statements are true about trust boundaries in the campus network? (Choose three.)

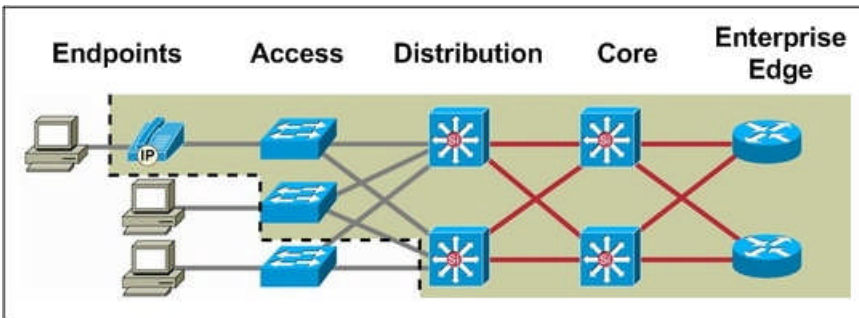

- A. A device is trusted if it correctly classifies packets.
- B. A device is trusted if it correctly declassifies packets.
- C. The outermost trusted devices represent the trust boundary.
- D. Classification and marking occur using 802.1ab QoS bits before reaching the trust boundary.
- E. Network trust boundaries are automatically configured in IOS version 12.3 and later.
- F. For scalability, classification should be done as close to the edge as possible.

Answer: ACF

12. Refer to the exhibit. The command spanning-tree guard root is configured on interface Gi0/0 on both switch S2 and S5. The global configuration command spanning-tree uplinkfast has been configured on both switch S2 and S5. The link between switch S4 and S5 fails. Will Host A be able to reach Host B?

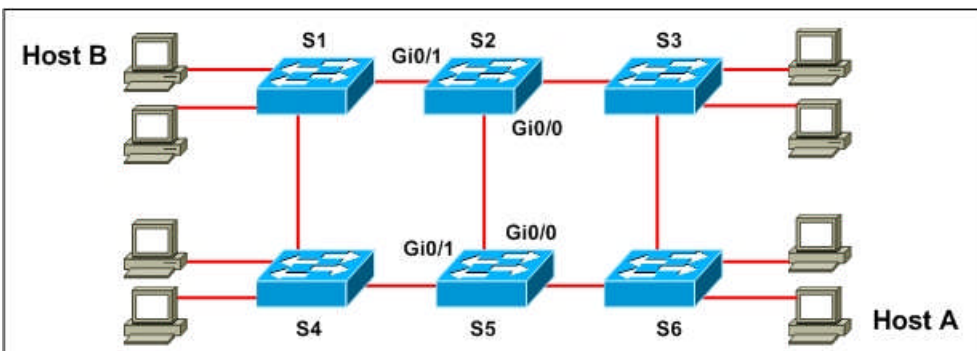

- A. Yes. Traffic can pass either from switch S6 to S3 to S2 to S1, or, from switch S6 to S5 to S2 to S1.

- B. No. Traffic will pass from switch S6 to S5 and dead-end at interface Gi 0/0.
- C. No. Traffic will loop back and forth between switch S5 and S2.
- D. Yes. Traffic will pass from switch S6 to S3 to S2 to S1.
- E. No. Traffic will either pass from switch S6 to S5 and dead-end, or traffic will pass from switch S6 to S3 to S2 and dead-end.

Answer: D

13. Refer to the exhibit. A Cisco Aironet Wireless LAN Client Adapter has been installed and configured through the ADU on the PC. The Aironet System Tray Utility (ASTU) has been enabled during the installation and the icon appears in the system tray area in the lower right of the desktop. What is the significance of the icon?



- A. It indicates that the radio of the client adapter is disabled.
- B. It indicates that the client adapter is not associated to an access point or another client.
- C. It indicates that the client adapter is associated to an access point or another client, but the user is not EAP authenticated.
- D. It indicates that the client adapter is associated to an access point or another client, that the user is authenticated if the client adapter is configured for EAP authentication, and that the signal strength is excellent or good.
- E. It indicates that the client adapter is associated to an access point or another client, that the user is authenticated if the client adapter is configured for EAP authentication, and that the signal strength is fair.
- F. It indicates that the client adapter is associated to an access point or another client, that the user is authenticated if the client adapter is configured for EAP authentication, and that the signal strength is poor.

Answer: F

14. Which description correctly describes a MAC address flooding attack?

- A. The attacking device crafts ARP replies intended for valid hosts. The MAC address of the attacking

- device then becomes the destination address found in the Layer 2 frames sent by the valid network device.
- B. The attacking device crafts ARP replies intended for valid hosts. The MAC address of the attacking device then becomes the source address found in the Layer 2 frames sent by the valid network device.
- C. The attacking device spoofs a destination MAC address of a valid host currently in the CAM table. The switch then forwards frames destined for the valid host to the attacking device.
- D. The attacking device spoofs a source MAC address of a valid host currently in the CAM table. The switch then forwards frames destined for the valid host to the attacking device.
- E. Frames with unique, invalid destination MAC addresses flood the switch and exhaust CAM table space. The result is that new entries cannot be inserted because of the exhausted CAM table space, and traffic is subsequently flooded out all ports.
- F. Frames with unique, invalid source MAC addresses flood the switch and exhaust CAM table space. The result is that new entries cannot be inserted because of the exhausted CAM table space, and traffic is subsequently flooded out all ports.

Answer: F

15. Refer to the exhibit. An attacker is connected to interface Fa0/11 on switch A-SW2 and attempts to establish a DHCP server for a man-in-middle attack. Which recommendation, if followed, would mitigate this type of attack?

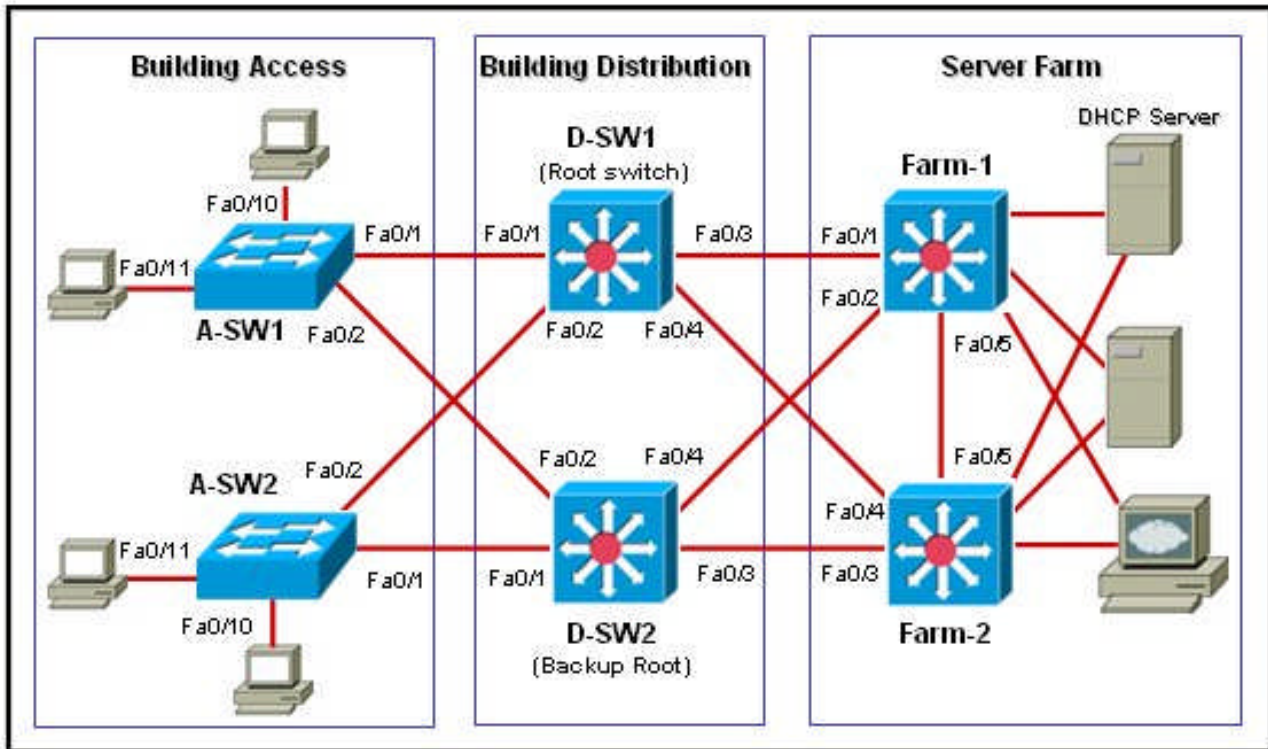

- A. All switch ports in the Building Access block should be configured as DHCP trusted ports.
- B. All switch ports in the Building Access block should be configured as DHCP untrusted ports.
- C. All switch ports connecting to hosts in the Building Access block should be configured as DHCP trusted ports.
- D. All switch ports connecting to hosts in the Building Access block should be configured as DHCP untrusted ports.
- E. All switch ports in the Server Farm block should be configured as DHCP untrusted ports.
- F. All switch ports connecting to servers in the Server Farm block should be configured as DHCP untrusted ports.

Answer: D

16. A client is searching for an access point (AP). What is the correct process order that the client and access point go through to create a connection?
- A. probe request/response, authentication request/response, association request/response
 - B. association request/response, authentication request/response, probe request/response
 - C. probe request/response, association request/response, authentication request/response
 - D. association request/response, probe request/response, authentication request/response

Answer: A

17. Which two types of activities does the Lightweight Access Point Protocol (LWAPP) define? (Choose two.)

- A. access point certification and software control
- B. compression and Layer 3 address mapping
- C. Layer 3 addressing and distribution
- D. packet encapsulation, fragmentation, and formatting
- E. SNMP monitoring services

Answer: AD

18. Which statement about the Lightweight Access Point Protocol (LWAPP) protocol is true?

- A. The processing of 802.11 data and management protocols and access point capabilities is distributed between a lightweight access point and a centralized WLAN controller.
- B. LWAPP aggregates radio management forward information and sends it to a wireless LAN solution engine.
- C. LWAPP authenticates all access points in the subnet and establishes a secure communication channel with each of them.
- D. LWAPP advertises its WDS capability and participates in electing the best WDS device for the wireless LAN.

Answer: A

19. Which statement describes the function of a trust boundary?

- A. Trust boundaries determine whether certain types of traffic can pass.
- B. Trust boundaries are a point in the network where decisions about CoS markings on incoming packets are made.
- C. Trust boundaries are a point in the network where QoS functionality begins and ends.
- D. Trust boundaries are points in the network where Layer 2 CoS markings are converted to Layer 3 DSCP or IP precedence markings.

Answer: B

20. Which statement is true about utilizing a data network for voice traffic?

- A. Adding bandwidth to the data network is the primary solution to provide for the needs of voice traffic.
- B. Because voice traffic volume cannot be calculated, network bandwidth requirements must be determined from an existing installation.
- C. Voice traffic will require some form of QoS mechanisms in most networks.
- D. Voice traffic will require some form of QoS implementation only in congested networks.
- E. Network congestion must be totally eliminated to provide proper voice traffic performance.

Answer: C



Contact Test4pass

We are proud of our high-quality customer service, which serves you around the clock 24/7.

To get your problem resolved instantly, live support

Read Our Frequently Asked Questions (FAQs)

We have gathered the most frequently asked questions for you. Please read our list of FAQs.

Contact us by Live Messenger

Sales: [Test4pass\(at\)hotmail.com](mailto:Test4pass(at)hotmail.com)

You can reach us at any of the email addresses listed below

Please allow up to 24 hours for us to respond

- MSN: Test4pass@hotmail.com